

MECHANICAL DRAWING: FPS1050-A4M00

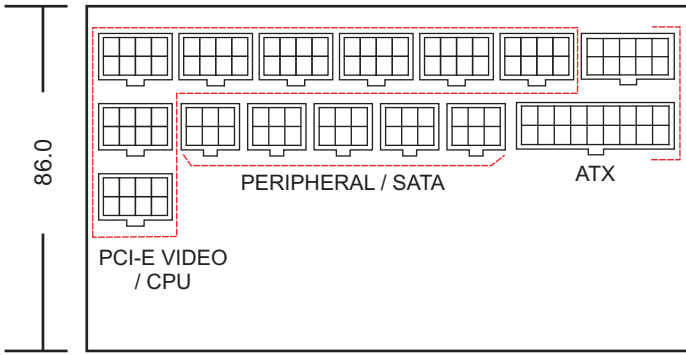

ALL CASE MEASUREMENTS ARE IN mm

5.9" X 3.4" X 7.1" (W X H X D)

ALL WIRE LENGTHS ARE IN INCHES

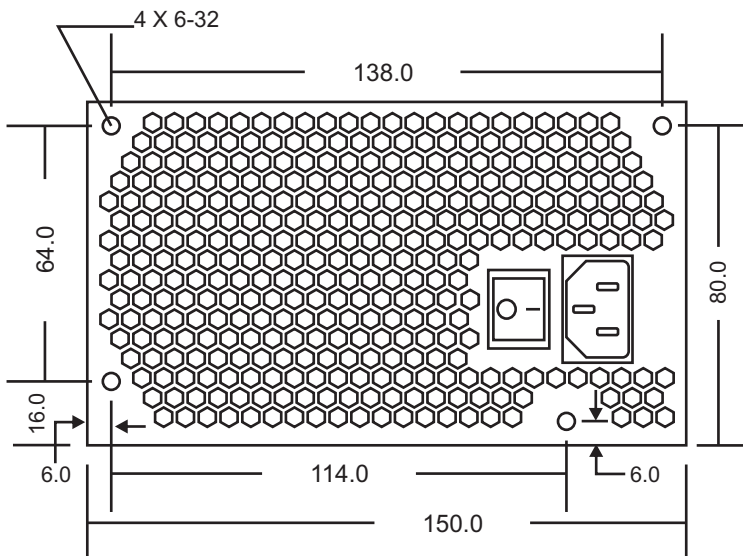
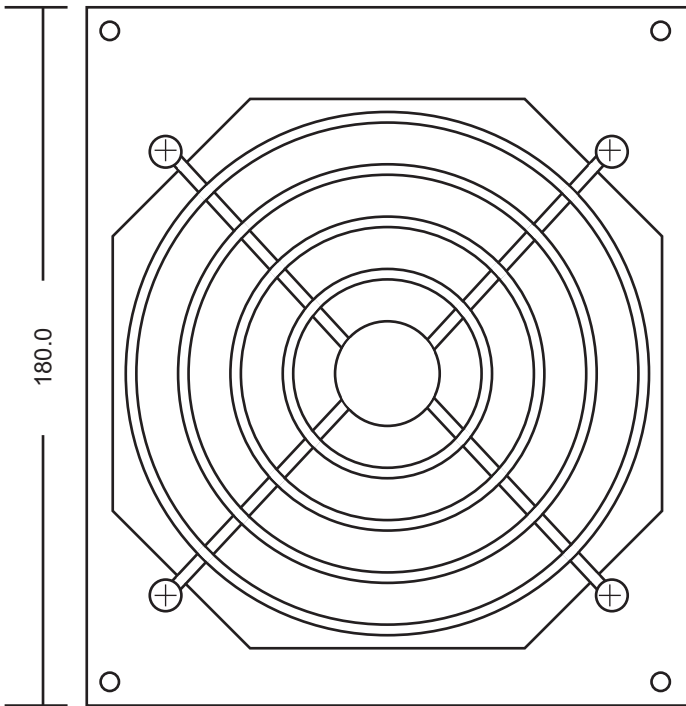

Sleeved Cable

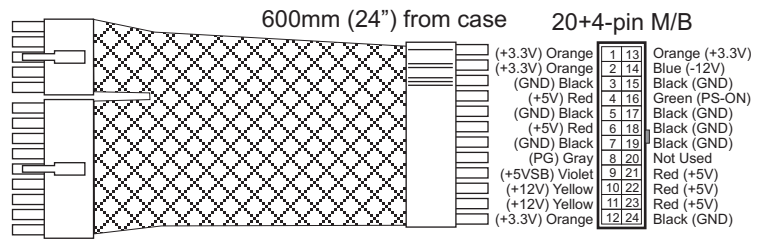

Flat Ribbon Cables

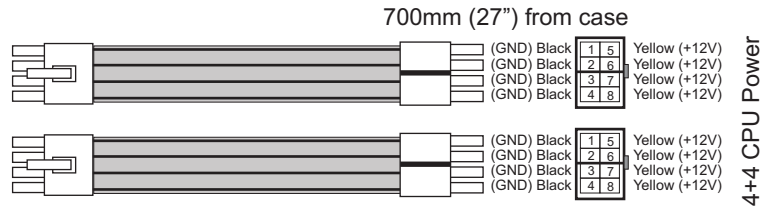

4+4 CPU Power

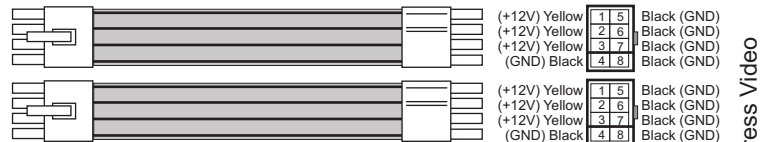
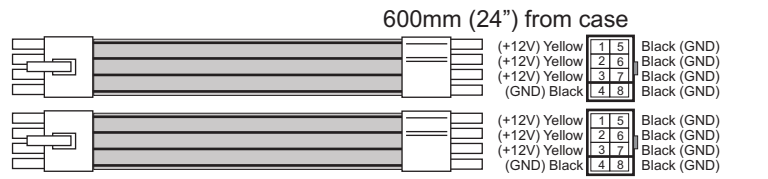

6+2 PCI Express Video

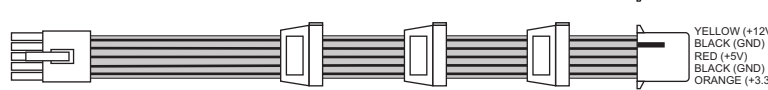
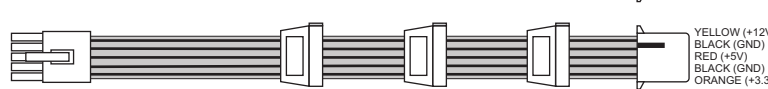
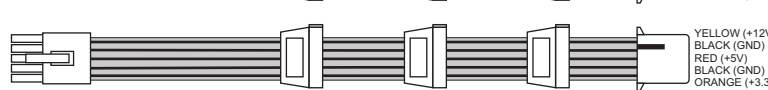
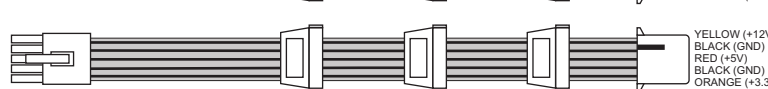
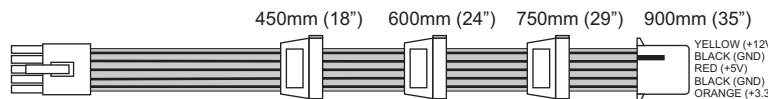
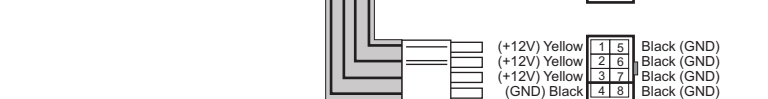
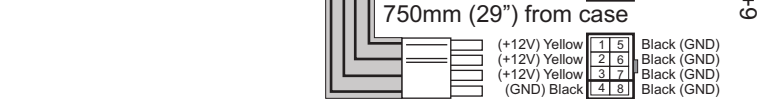
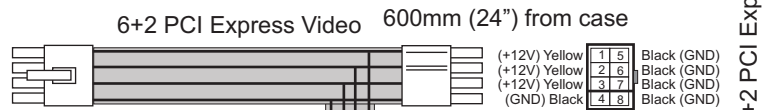

Daisy Chained Serial ATA IDE/Peripheral